

KylCity

CKF-700

Refrigerator/Freezer



CE

TECHNICAL INFORMATION

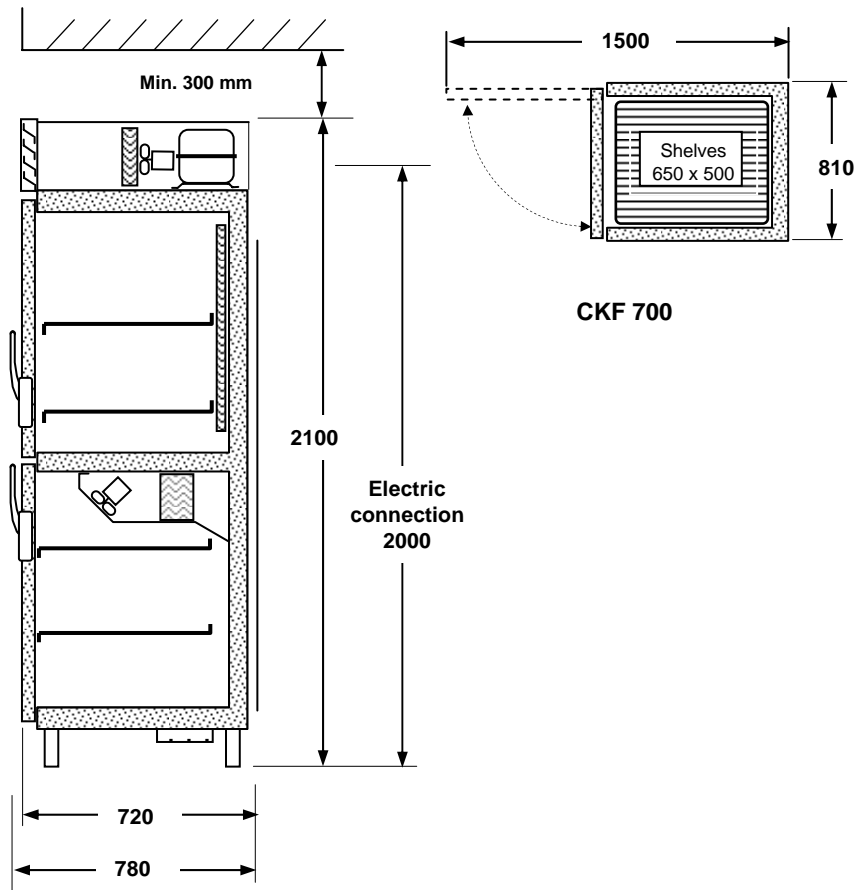

CKF-A = incl. compressor

CKF-C = excl. compressor

Design outside:

St. steel 2333

Design inside:

St. steel 2333

Insulation:

Freon free polyuretan

Defrost: Automatic

Compressor: Integrated pipe-system

Door: Magnetic seal and lockable handles

Shelves: Crom

Ventilation requirements:

620 m³/h

Defrost water heater: Not standard

Typ	CKF-A 700		CKF-C 700	
		REFRIGERATOR / FREEZER	REFRIGERATOR / FREEZER	
Gross volume	L	315	315	315
Temp. area	C	-1°..+12°		-1°..+12°
Outside temp.		+32°		
Cooling cap t ₂ = -10°/ -30° C	W	185	280	185
Power	V/Hz	230 50/60		20
Connection effect	W	550		0,2
Energy use*	Kwh/day	6,4		0.1
Amp.	A	7		-
Sound	dB(A)	57		
Cooling system		R 134 A	R 452 A	R 134 A
Weight	Kg	130		125

With delivery compressor, the cooling pipes and cables are located on top of cabinet. Thermostat, magnetic valve and expansion valve are mounted.

*Time running 14 hours/24 hours

